

CLS

INSPIRAMOS A SUA SEGURANÇA

GVS

FILTER TECHNOLOGY



RESPIRATORY PROTECTION

GVS FILTER TECHNOLOGY

The GVS Group is one of the world's leading manufacturers of filter solutions for applications in the Healthcare & Life Sciences, Energy & Mobility and Health & Safety sectors. GVS technology promotes health and safety in highly regulated environments. Throughout its 40-year history, GVS has evolved from a supplier of components for the healthcare sector to a global Group that provides a range of diversified, high-tech filtration solutions.



SAFETY

INNOVATIVE DESIGN, COMPACT PROFILE, REPLACEABLE FILTERS, HYPO-ALLERGENIC MATERIALS FOR A UNIQUE KIND OF COMFORT, HESPA™ EFFICIENCY PROTECTION, LOW BREATHING RESISTANCE

COMFORTABLE - LIGHT - COMPACT

The Elipse® range of face masks, designed, developed and made in the UK by GVS, represents a major advance in mask design. As one of the lightest on the market in its class, its ergonomic shape provides maximum visibility to wearers, can safely be worn with goggles, helmets and hearing protection. The ability to replace the filters extends the mask's overall working life. These compact profile masks are made of hypo-allergenic materials and the replaceable filters offer a minimum efficiency of 99,95% or higher at 0,3 microns particle size.

FIT THE CONTOURS OF YOUR FACE

A range of extremely lightweight masks that fit perfectly to the face, without hindering the user. The compact profile of the body and filters allows all Elipse® range masks to perfectly seal to the face and ensure the greatest possible field of vision during use, without interfering with other eye or ear protection which users are required to wear. Elipse® comes in 2 sizes.

SOFT AND HYPO-ALLERGENIC

Unique comfort, thanks to the flexible and soft characteristics of the TPE (Thermo Plastic Elastomer) used in the Elipse® masks, making them very comfortable even for extended use. The materials that make up the mask are odourless and hypo-allergenic, "FDA" compatible, latex and silicone free. Conforms to ISO 109903-10:2010 skin irritation test of facemask.

The safe choice
100% of filters are
efficiency tested

PATENTED TECHNOLOGY

The Encapsulation is a patented technology owned by the GVS Group which enables the production of a compact and lightweight filter capturing the pleated media with a soft TPE ring.

HESPA™ P3 FILTERS

"High Efficiency Synthetic Particulate Air Filter" (HESPA) is a technology used in all of the Elipse® range, which gives the patented "encapsulation" production process. The 7 layers of combined filter media uses exclusive mechanical filtration technology, guaranteeing the filter efficiency will remain above 99.95% during use. The filters are also water repellent thanks to the nature of the media.

PROTECTION AGAINST NANO PARTICULATES

GVS Elipse P3 particulate filters protect against nano particulates, and have been tested down to 40 nanometers (0.04 microns) still giving an efficiency of →99.95%.



GUIDE TO RESPIRATORY PROTECTION

Indications for the choice of respiratory protection devices are based on current knowledge. Before each use of the Elipse® respirator device, the buyer and user must ensure that the masks and filters used are those specified for the type of pollutant and its concentrations. The ultimate responsibility concerning selection and use of products lies solely with the buyer and user.

TYPES OF FILTERS

Dust filters are designed to be able to retain airborne particulates and are offered in various constructions, each enhancing the filter's characteristics with use of various types of filter material with different thickness, porosity and types of finish. This enables them to protect against particulates, gases and nuisance odours. Cartridge filters contain specific activated carbon, which retain certain gases and vapours by adsorption, while combined filters can remove both gases, vapours and particulates.

TECHNICAL CHARACTERISTICS OF FILTERS

There are various types of particulate dust filters which have different filtration efficiencies. Depending on which you choose, you can have the most suitable means of protection against environmental hazards. The airborne particles are retained by the filter by means of mechanical and/or electrostatic action.

In the case of gas filters, substances are retained by the chemical-physical action of the activated carbon contained in the filter, able to adsorb and neutralise contaminants. It is assumed that the efficiency of gas and vapour interception on adsorbent material is 100%, at least until the capacity of the filter material is reached. For gas filters, we refer to ; time to completion or, rather, the period beyond which the filter is saturated and the pollutant begins to pass through the filter. This 'breakthrough' time depends on the quantity and quality of the adsorbent material used, on the active area of the cartridge, on its filtration capacity against the pollutant and on environmental concentrations and conditions.

FACE FIT TESTING

Face fit testing is the method used to ensure that a face mask is correctly fitted so that there is no inward leakage of unfiltered air bypassing the edges of the mask. The first objective of the test is to confirm that the wearer knows how to correctly fit the mask by adjusting the straps as well as to validate its performance on the user. The second objective is to verify that the wearer uses a product type or size that fits them correctly.

There are two main methods:

- Qualitative: The test subject dons the appropriate RPE, then places a hood over their head creating a chamber. Solution, such as, Bitrex is sprayed into the hood whilst the test subject carries out a number of exercises. The solution should only be tasted if the RPE is poorly fitted.
- Quantitative: The subject is tested via a Portacount that will measure the number of particles in the atmosphere versus the number of particles inside the mask, this allows you to calculate a Fit Factor. This type of test also allows you to accurately compare various models of respirators suitability.

DO YOU WANT A FACE FIT? CONTACT US TO FIND OUT ABOUT OUR FACE FIT TESTING SERVICE.



SPM002
Qualitative Face Fit Kit



SPM414
Portacount Face Fit Kit adaptor

Protection against particulate (dust, mists and toxic fumes)



DUST: dust forms when a solid material is broken down into tiny fragments. The finer the dust, the higher the risk.



MISTS: mists are tiny droplets that are formed from liquid materials by atomisation and condensation processes, such as spray painting.



FUMES: fumes are formed when a solid material is vaporised by the high heat. The vapour cools quickly and condenses into very fine particles.

Respiratory filters have 3 classes of protection in EN143 with increasing efficiency, normally expressed with a Nominal Protection Factor (NPF) which is the ratio between concentration of the contaminant in the environment and inside the mask. The resulting factor indicates how many times the device can reduce the external concentration.

Classes of efficiency of dust respirators

Classes of efficiency of dust respirators	Minimum total filtration efficiency	NPF	Max external concentration
P1	80%	4	Up to 4 x TLV
P2	94%	10	Up to 10 x TLV
P3	99,95%	40	Up to 40 x TLV





Anti-dust filters are distinguished by the colour WHITE.

Protection against gases and vapours



Gases and vapours are molecules so small that they penetrate particulate filters. You need to use a gas cartridge filter against these.

The Elipse gas or combined gas and particulate respirators provide specific protection to the user by physical or chemical adsorption, withholding the harmful substances that are distinguished by identifying letters and colours:

Type	Protection	Class
 A	organic gases and vapours with a boiling point above 65°C	1, 2
 B	inorganic gases and vapours (excluding carbon monoxide)	1, 2
 E	sulphur dioxide and other acidic gases and vapours	1, 2
 K	ammonia and organic ammonia derivatives	1, 2
 AX	certain organic gases and vapours with a boiling point ≤ 65 °C. For single use only.	









There are different protection classes for each type of gas filter, depending on the amount of contaminants that the filter is able to adsorb. The choice is therefore determined by the predicted concentration of the pollutant:

Class	Capacity	Limit of use
1	low	1,000 ppm
2	medium	5,000 ppm

Combined filters (gas and particulate), besides the colour of the specific gas/es, include a white band and their marking shows all the distinctive letters with their relative efficiency classes.

GUIDE TO CHOOSING RESPIRATORY AND FILTERS



INDUSTRY	HARMFUL SUBSTANCE / RISK	Suggested Filter				
		P3	P3 nuisance	A1P3	B1P3	ABE1P3
 Agriculture	Grain Dust	✓				
	Pesticides			✓		✓
 Automotive	Paint Vapour until 5000ppm					
 Construction	Silica Dust	✓				
	Paint Vapour until 1000ppm			✓		✓
	Asbestos	✓		✓		✓
	Moulds		✓	✓		✓
	Concrete Dust	✓				
 Building Materials	Stone Dust	✓				
	Aggregate Dust	✓				
	Wood Dust	✓				
	Cement Dust	✓				
 Food	Poultry	✓				
	Powders (Dairy)	✓				
 Manufacturing	Glass Fibres	✓				
	Cyclohexane			✓		✓
	Composite Fibres	✓				
	Solvents			✓		✓
	Lead Fumes	✓				
	Chlorine				✓	✓
	Formaldehyde				✓	✓
	Sulfuric Acid (gas only)					✓
	Sulfuric Acid (powder)					✓
	Ammonia based chemicals					
 Mining	Coal Dust	✓				
	Silica Dust	✓				
 Welding and Metal Industry	Metal (any)	✓	✓			
	Painted metal (repair)			✓		✓

This is only a guideline that will recommend the lowest level of protection suitable, and for only one contaminant at a time.



Suggested Filter					
A1	AE1	E1	A2P3	ABEK	ABEKP3
			✓	✓	✓
			✓		
✓	✓		✓	✓	✓
✓	✓		✓		✓
					✓
	✓	✓		✓	✓
				✓	✓
				✓	✓
				✓	✓
			✓		✓

It is the responsibility of the user to choose the adequate protection for the workplace.
 For more detailed information please contact your sales advisor locally.

GVS ELIPSE MASKS SIZE GUIDE

Face Length

Distance from the bridge of your nose to the point of your chin

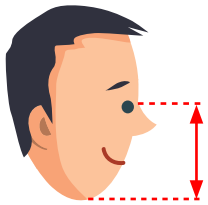

128.5 mm - 138.5 mm	M/L	M/L	M/L
118.5 mm - 128.5 mm	S/M	M/L	M/L
108.5 mm - 118.5 mm	S/M	S/M	M/L
98.5 mm - 108.5 mm	S/M	S/M	S/M
120.5 mm - 133 mm		133 mm - 146 mm	146 mm - 158.5 mm

Face Width

Distance between the Zygomatic Arches

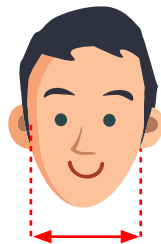

*Note: Size Chart is a guide only, correct sizing and fitment (fit) must be determined using either a quantitative or qualitative face fit test in accordance with national / local regulations.



FILTER TECHNOLOGY

Designed to fit
the contours
of your face



ELIPSE DUST MASK - P3 HESPA™

With replaceable filters for dust, fumes and mists

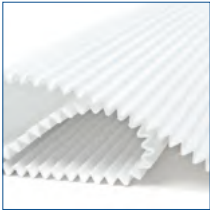

130 g



DESCRIPTION

Compact, lightweight and flexible design which adapts and fits perfectly to the face and offers a full range of vision without interfering with other eye or ear protection which users are required to wear. Large central non-return valve means lower breathing resistance for the user and keeps moisture build-up inside the mask to a minimum. Lightweight, non-slip strap that is easily adjusted in 4 positions for improved comfort and to allow safe use even in high humidity or wet conditions. Elipse® come in 2 sizes.

PROTECTION PROPERTIES

Effective against dust and fumes containing substances such as micro-organisms, marble, gypsum, titanium oxide, soapstone, rock wool, wood, detergents, textile fibres, spices, salt, animal feeds, etc.. Protects against dust that can cause lung disease. In particular, protects against coal, silica, cotton, iron ore, graphite, kaolin, zinc, aluminium dusts. Protects against harmful dusts such as asbestos, bauxite, coal, silica, iron, and against toxic dusts such as manganese, lead and chromium.

Pleated, interchangeable P3 filters have a minimum efficiency of 99,95% at 0,3 microns and a breathing resistance of 3 mbar at a flow rate of 47,5 l/min for each filter.

APPLICATION

Mining, steel mills, foundries, mechanical, pharmaceutical, cement, glass, ceramics, chemicals, textile industries, shipyards, battery manufacturing, waste management, construction, heavy metals (lead, nickel, chromium), rail industry.

CERTIFICATIONS

Mask conforms to EN 140:1998
Filters conform to EN 143:2000+A1:2006
Masks and filters are CE certified.

MATERIALS

The materials used for masks and filters are hypo-allergenic, odourless, medical grade and without latex or silicone.

BATCH REPORTS

Full traceability of each batch against each material used.

ON LINE TESTING

100% of filters are efficiency tested with NaCl to ensure the highest performance and quality.

STORAGE LIFE

Elipse P3 R D : 5 years.
Elipse P3 Nuisance Odour R D : 5 years.



Dimensions

Mask: (S/M) 95 x 126 x 106 mm
(M/L) 95 x 133 x 106 mm
Filter: 12 x 94 x 50 mm

Weight

Mask + Filter: (S/M) 130 g; (M/L) 138 g
Mask body: 94 g
Filter only 18 g each

Material:

Mask: Medical grade TPE (Silicone free).
Filters: Mechanical type HESPA™
Synthetic media with TPE over molded / encapsulated. Filters are water repellent and re-usable.

Lifetime:

Filters can be used until fully clogged and / or when the wearer feels uncomfortable. The lifetime will depend on the concentration in the workplace and the activity level. The filtration level will stay constant and superior at 99.95% or greater throughout its use.
The mask is durable and the lifetime depends on the storage and care. It is advised to use the carry case below.



SPR299 (S/M) SPR501 (M/L)
Elipse Half Mask
complete with P3 filters

SPR316
Elipse P3
replacement filters



SPR337 (S/M) SPR502 (M/L)
Elipse Half Mask complete with
P3 nuisance odour filters

SPR336
Elipse P3 nuisance
odour replacement filters



SPM001
Elipse Dust Mask Carry
Case (Belt holder)



SPM414
Portacount Face
Fit Kit adaptor

ELIPSE
EN 140 + EN 143



VS



DISPOSABLE MASKS EN 149



COMFORT



<2%

LEAKAGE

<5%

>99,95%

P3 FILTRATION

99%

0,3 µm

DUST PROTECTION
MICRON SIZE TESTED

0,6 µm



WASTE REDUCTION

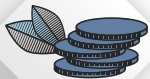

COST SAVINGS



Please contact your GVS representative for a cost saving demonstration

EVER WONDER ABOUT THE LIFESPAN OF YOUR DUST FILTERS?

% LIFESPAN



100%



40%



EN143 and EN149 states that the inhalation breathing resistance after clogging shall not exceed 7 mbar for a P3 respirator tested at 95l/min.

This can be interpreted as the limit for the wearer to use the respirator safely, and therefore the time to change the filters or the mask.

Do you want to set up a standard operating limit in your plant and workshop?

GVS can test your used filters, contact your local representative for more details or write to gvsuk@gvs.com.

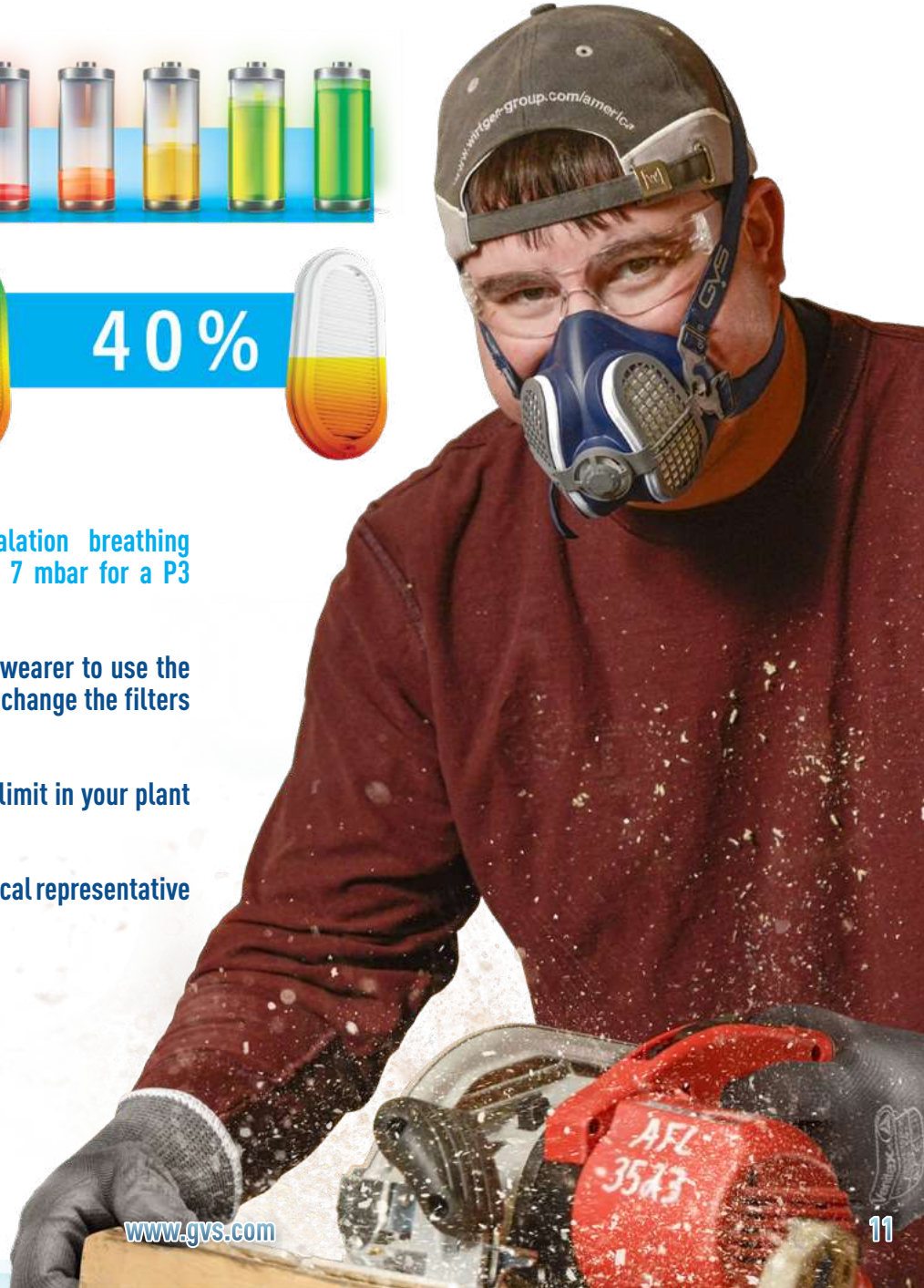

Fogging

Leakage

Uncomfortable and non-adjustable

Low efficiency and short life disposable filter

No fogging +

Soft hypoallergenic TPE material +

Fits to your face +

HESPA™ High Efficiency (>99,99%) Reusable and replaceable filters +

Pleated filter to reduce breathing resistance +

COST REDUCTION UP TO 50%

Using GVS Elipse instead of disposable respirator



FILTER TECHNOLOGY

Low Profile
Gas and Dust
filters & masks



ELIPSE LOW PROFILE GAS & PARTICULATE MASK



DESCRIPTION

Compact, lightweight and flexible design which adapts and fits perfectly to the face and offers a full range of visibility without interfering with other eye or ear protections which users choose to wear.

Large central non-return valve which allows for a reduction of breathing resistance for the user and keeps moisture build-up inside the mask to a minimum. Lightweight, non-slip strap that is easily adjusted in 4 positions for improved comfort and to allow safe use even in high humidity or wet conditions. Elipse® comes in 2 sizes.

PROTECTION PROPERTIES

The gas cartridges contain specific activated carbon granules with optimised characteristics such as pore size, grain size, activity level, density etc, which provide a maximum adsorption performance and a low breathing resistance. Each respirator is supplied pre-fitted with two gas cartridge filters for the protection against a range of gases, vapours, dust and mists. Once the cartridges are finished, they can be replaced with new filters. These offer versatile protection against substances in concentrations up to 1,000 ppm and from dust and mists up to 50 TLV.

APPLICATION

- A1P3: Painting, Solvents into Automotive and Shipyard industry or repair.
- B1P3: Manufacturing using Iodine, Chlorine or Formaldehyde such as in insulation, industrial or consumer products, metal separation, microelectronics.
- ABE1P3: Multigas and dust risks (excluding ammonia), in chemical production and handling environment.

CERTIFICATIONS

- Mask conforms to EN 140:1998
- Filters conform to EN 14387:2004+A1:2008
- Maintenance Free masks conform to EN 405:2001+A1:2009
- Masks and filters are CE certified.

MATERIALS

The materials used for masks and filters are hypo-allergenic, odourless, FDA compatible and Non latex or silicone.

BATCH REPORTS

Full traceability of each batch against each material used.

ON LINE TESTING

100% of filters are efficiency tested with NaCl to ensure the highest performance and quality.

STORAGE LIFE:

3 years, for mask and filters.

ELIPSE LOW PROFILE GAS MASK CHARACTERISTICS

Dimensions

Mask: (S/M) 97 x 126 x 138 mm
(M/L) 97 x 133 x 138 mm
Filter: 48,5 x 94,5 x 60 mm

Weight

Mask + Filter: (S/M) from 267 to 280 g;
(M/L) from 271 to 284 g
Mask body: 87 g
Filter only from 90 to 95 g each

Material:

Mask: Medical grade TPE (Silicone free).
Filters:

- Activated carbon with ABS shell.
- Mechanical type HESPA™ Synthetic media with TPE over mould / encapsulation.

Lifetime:

Filters can be used until fully clogged and / or the wearer feels uncomfortable or until the activated carbon is exhausted and the wearer can smell / taste the contaminant. The lifetime will depend on the concentration in the workplace and the activity level. The filtration level will stay constant throughout the usage. All masks are supplied with an aluminium zip foil bag for storage to maximize the life expectancy of the activated carbon. The particulate element lifetime can also be increased by usage of our pre-filter kits below.

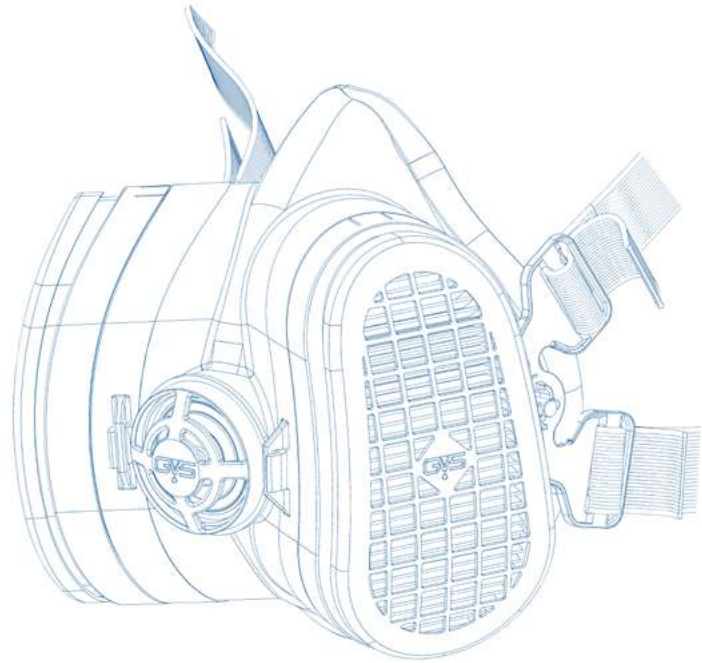

Large 198 cm² surface area
of HESPA™ P3 media

Activated carbon for
gas absorption

Structure to help airflow
diffusion and full usage
of the activated carbon

Large inhalation valve
to allow air flow

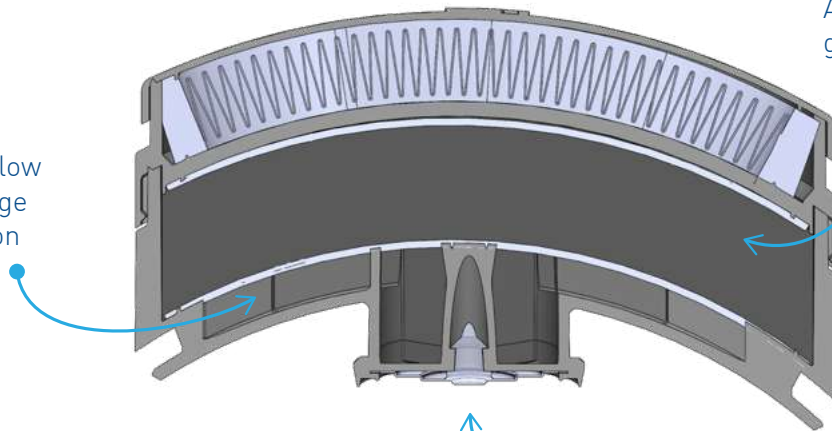



SPR338 (S/M) SPR503 (M/L)
A1P3 Reusable Half Mask
for Organic Gases and Dust

SPR341
Pair of replacement
A1P3 Filters



SPR425 (S/M) SPR505 (M/L)
B1P3 Reusable Half Mask for
Inorganic Gases and Dust

SPR426
Pair of replacement
B1P3 Filters



SPR580 (S/M) SPR581 (M/L)
ABE1P3 Reusable Half Mask for Organic,
Inorganic and Chemical Gases and Dust

SPR582
Pair of replacement
ABE1P3 Filters



SPR359 (S/M) SPR504 (M/L)
FFA1P3 Maintenance Free Half Mask for Organic
Gases and Dust Filters can not be replaced



SPM421
Kit of Prefilters
20 pads



SPM420
Kit of Prefilter Kits
2 holder and 10 pads



SPM008
GVS Low Profile
Mask Carry Case



FILTER TECHNOLOGY

High Performance
Gas filters and masks



ELIPSE HIGH PERFORMANCE GAS & MASK

The complete gas filter range



DESCRIPTION

Compact, lightweight and flexible design which adapts and fits perfectly to the face and offers a full range of visibility without interfering with other eye or ear protections which users choose to wear.





Cartridge filters with lower breathing resistance, increase in gas performance and greater duration of use.

Easy to adjust headband clip with enhanced retention performance. Elipse® comes in 2 sizes (small / medium & medium / large).

PROTECTION PROPERTIES

The gas cartridges contain specific activated carbon granules with optimised characteristics such as pore size, grain size, activity level, density etc, which provide a maximum adsorption performance and a really low breathing resistance. Each respirator is supplied pre-fitted with two gas or combined gas & particulate cartridge filters for the protection against a range of gases, vapours, dust and mists. Once the cartridges are finished, they can be replaced with new filters. These offer versatile protection against substances in concentrations up to 5,000 ppm and from dust and mists up to 50 TLV.

APPLICATION

Type	Protection
 A	organic gases and vapours with a boiling point above 65°C
 B	inorganic gases and vapours (excluding carbon monoxide)
 E	sulphur dioxide and other acidic gases and vapours
 K	ammonia and organic ammonia derivatives
 AX	certain organic gases and vapours with a boiling point ≤ 65 °C. For single use only.

CERTIFICATIONS

Mask conforms to EN 140:1998

Filters conform to EN 14387:2004+A1:2008

Maintenance Free masks conform to EN 405:2001+A1:2009

Masks and filters are CE certified.

MATERIALS

The materials used for masks and filters are hypo-allergenic, odourless, FDA compatible and Non latex or silicone.

BATCH REPORTS

Full traceability of each batch against each material used.

ON LINE TESTING

100% of filters are efficiency tested with NaCl to ensure the highest performance and quality.

STORAGE LIFE

3 years, for mask and filters.

ELIPSE HIGH PERFORMANCE GAS MASK CHARACTERISTICS

Dimensions

Mask (straight carbon):
(S/M) 120 x 126 x 171 mm
(M/L) 120 x 133 x 171 mm
Mask (with P3 Dust):
(S/M) 120 x 126 x 171 mm
(M/L) 123 x 126 x 189 mm
Filter (straight carbon): 85 x 94,5 x 45 mm
Filter (with P3 Dust): 90 x 94,5 x 55 mm

Weight

Mask + Filter: from 290 to 384 g
Mask body: 106 g
Filter: from 92 to 142,5 g

Material:

Mask: Medical grade TPE (Silicone free).

Filters:

- Activated carbon with ABS shell.
- Mechanical type HESPA™ Synthetic media with TPE over mould / encapsulation (for combined filters with P3 protection).



Lifetime:

Filters can be used until fully clogged and / or the wearer feels uncomfortable wor until the activated carbon is exhausted and the wearer can smell / taste the contaminant. The lifetime will depend on the concentration in the workplace and the activity level. The filtration level will stay constant all along the usage. All masks are supplied with an aluminium zip foil bag for storage to maximize the life expectancy of the activated carbon. The P3 element is designed for a longer lifetime with double the amount of material usually put in other ranges.

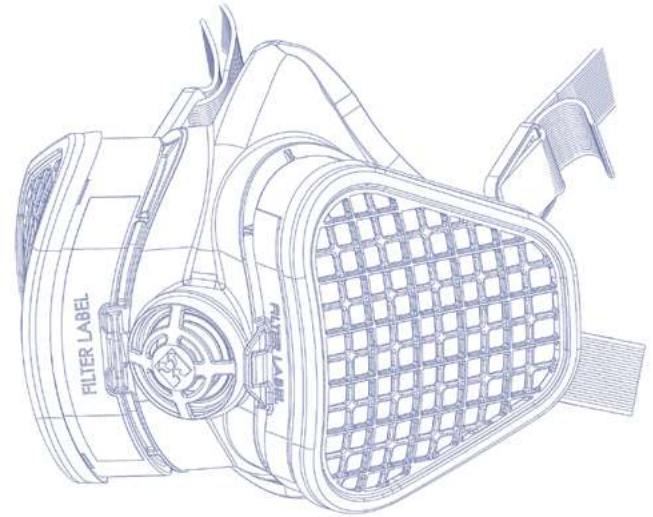

Large 376 cm² surface area of HESPA™ P3 media.

Activated carbon for gas adsorption

Structure to help airflow diffusion and full usage of the activated carbon

Large inhalation valve to allow air flow.

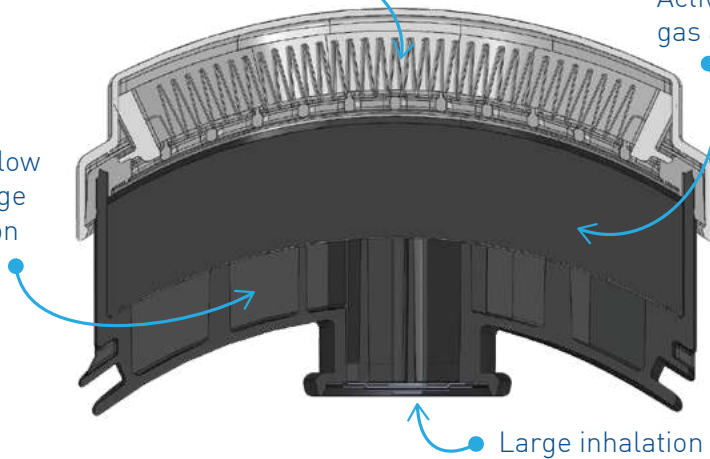



SPR497
A2P3 Replacement filters

SPR495 (S/M) SPR496 (M/L)
A2P3 Reusable Half Mask Organic
Gases and Vapours until 5000 ppm and Dust



SPR492
ABEK1P3 Replacement filters

SPR490 (S/M) SPR491 (M/L)
ABEK1P3 Reusable Half Mask for multiple
Gases and Vapours and Dust



SPR498 (S/M) SPR499 (M/L)
FFA2P3 (EN405) Maintenance Free Organic Gases and
Vapours until 5000 ppm and Dust Filters can not be replaced



SPR493 (S/M) SPR494 (M/L)
FFABEK1P3 (EN405) Maintenance Free Half Mask for multiple
Gases and Vapours and Dust Filters can not be replaced



SPM009
GVS High Performance Half
Mask Carry Case



SPM578
Head Cradle Accessory



SPR511 (S/M) SPR512 (M/L)
A1 Reusable Half Mask for Organic
Gases and Vapours until 1000 ppm



SPR513
A1 Replacement filters



SPR514 (S/M) SPR515 (M/L)
E1 Reusable Half Mask for
Acidic Gases and Vapours



SPR516
E1 Replacement filters



SPR517 (S/M) SPR518 (M/L)
AE1 Reusable Half Mask for Acidic
and Organic Gases and Vapours



SPR519
AE1 Replacement filters



SPR487 (S/M) SPR488 (M/L)
ABEK1 Reusable Half Mask for
multiple Gases and Vapours



SPR489
ABEK1 Replacement filters



SPM523
Case for replacement P3 filters
for High Performance Half Mask



SPM524
Pair of P3 replacement filters for
High Performance Half Mask



NEW CRADLE



- ✓ Added comfort
- ✓ Prevents headstrap from slipping
- ✓ Easily connects to the existing Elipse® headstrap
- ✓ Designed to fit under hard hats





elipse
integra

The 3/4 Mask
system



ELIPSE INTEGRA COMBINED EYE AND RESPIRATORY PROTECTION

The combined safety



DESCRIPTION





Compact, lightweight and flexible design which adapts and fits perfectly to the face and offers a unique and innovative combined protection, reducing risks of non-compatibility, non-conformity and mist build-up. Large central non-return exhalation valve which reduces the breathing resistance for the user and keeps moisture build-up inside the mask to a minimum. Lightweight, non-slip strap that is easily adjusted in 4 positions for improved comfort and to allow safe use even in high humidity or wet conditions. Elipse® Integra come in 2 sizes.

PROTECTION PROPERTIES

The lens is designed in Polycarbonate and can withstand 120 m per second impacts. The coating applied meets (N) Anti Fog and exceeds the standard (K) anti-scratch coating seen on the market for a longer durability. Elipse Integra is compatible with the current Elipse® filter range.

APPLICATION

Type Protection

	A	organic gases and vapours with a boiling point above 65°C
	B	inorganic gases and vapours (excluding carbon monoxide)
	E	sulphur dioxide and other acidic gases and vapours
	K	ammonia and organic ammonia derivatives
	AX	certain organic gases and vapours with a boiling point ≤ 65 °C. For single use only.

CERTIFICATIONS

Integra Mask (Goggle combined) conforms to EN 140:1998
Integra Mask (Goggle combined) conforms to EN 166:2002
Particulate filters conform to EN 143:2000+A1:2006
Gas and combined gas & particulate filters conform to EN 14387:2004+A1:2008
Integra Masks and filters are CE certified.



342 g



203 g



MATERIALS

The materials used for masks and filters are hypo-allergenic, odourless, FDA compatible and Non latex or silicone.

BATCH REPORTS

Full traceability of each batch against each material used.

ON LINE TESTING

100% of filters are efficiency tested with NaCl to ensure the highest performance and quality.

STORAGE LIFE:

3 years, for mask and filters for gases
5 years, for mask and filters for particulates
3 years, for mask and filters for particulates with nuisance odour

ELIPSE INTEGRA

Integra is tested and approved as one combined respiratory protection to EN 140.
It is the only half mask approved with permanently fixed safety eyewear

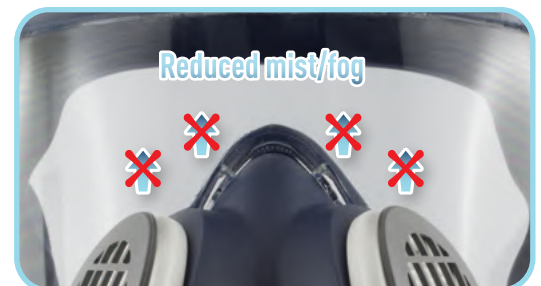



SPR407 (S/M) SPR406 (M/L)
P3 Elipse IntegraMask
for application with Dust only

SPR316
P3 replacement filters



SPR404 (S/M) SPR405 (M/L)
P3 Nuisance odour Elipse
Integra Mask for application with Dust only

SPR336
P3 nuisance odour
replacement filters



SPR444 (S/M) SPR401 (M/L)
A1P3 Elipse Integra Mask for application
with Organic Gases and Dust

SPR341
A1P3 replacement filters



SPR583 (S/M) SPR584 (M/L)
ABE1P3 Elipse Integra Mask for application with
Organic, Inorganic and Chemical Gases and Dust

SPR582
Pair of replacement
ABE1P3 Filters

Dimensions

Mask with P3: (S/M) 168 x 152 x 200 mm
(M/L) 174 x 152 x 200 mm

Mask with Combined Cartridges:

(S/M) 168 x 147 x 200 mm

(M/L) 174 x 149 x 200 mm

Mask with High Performance:

Combined Cartridges

(S/M) 168 x 153 x 200 mm

(M/L) 174 x 157 x 200 mm

Carbon Cartridges

(S/M) 168 x 151 x 200 mm

(M/L) 174 x 155 x 200 mm

Filter P3: 12 mm x 94 mm x 50 mm

Filter Combined: 48,5 x 94,5 x 60 mm

High Performance Filter: 95 x 55 x 60 mm



Weight

Mask with P3: from 203 g. to 213 g

Mask with Combined: (S/M) 337 g; (M/L) 350 g

Mask with High Performance: from 412 to 449 g

Filter P3: 18 g

Filter Combined: from 90 to 95 g

High Performance Filter: from 92 to 142,5 g

Material

Mask: Medical grade TPE (Silicone free).

Goggle lens: Polycarbonate with flow coating for

anti-scratch/anti-fog.

Goggle face seal: Medical grade TPE (Silicone free).

Lifetime

Filters are identical to Elipse® Range and follow the same criteria for lifetime. Filters can be used for both Elipse® and Integra Range.





SPR538 (S/M) SPR539 (M/L)
ABEK1 Elipse Integra Mask for multiple Gases and Vapours



SPR489
ABEK1
Replacement filters



SPR536 (S/M) SPR537 (M/L)
A2P3 Elipse Integra Half Mask Organic Gases and Vapours until 5000 ppm and Dust



SPR497
A2P3
Replacement filters



SPR534 (S/M) SPR535 (M/L)
ABEK1P3 Elipse Integra Mask for multiple Gases and Vapours and Dust



SPR492
ABEK1P3
Replacement filters

NEW ACCESSORY



Elipse Integra RX insert



SPM520
Peel off visor x 10



SPM523
Case for replacement P3 filters for High Performance Half Mask



SPM524
Pair of P3 replacement filters for High Performance Half Mask



SPM007
Integra Case

GVS MASKS SPARE PARTS LIST



SPM558

Elipse Mask Particulate Strap Support Assembly



SPM559

Elipse Integra Particulate Strap Support Assembly



SPM565

Elipse Mask slim rubber headband pad



SPM578

Elipse Mask cradle pad



SPM571

Pair of elastics for Elipse Masks



SPM566

Valve cover for All Elipse Gas Masks



SPM568

Pack of 3 valve diaphragms for Elipse Masks and Gas filters



SPM562

Plastic cover kit for Low Profile Elipse Gas Mask/Filters



SPM561

Pack of 4 headband clips for Elipse Integra and Elipse High Efficiency Gas Masks



SPM563

Pack of 2 turnbuckles for Elipse Masks



SPM560

Pack of 2 headband connector for Elipse Low Profile Gas Masks



SPM564

Pack of 2 headband connectors for Elipse High Efficiency Gas Mask



SPM569

Pack of 2 headband connector for Elipse Integra Low Profile Gas Masks



SPM567

Pack of 2 headband connectors for Elipse Integra High Efficiency Gas Mask



FILTER TECHNOLOGY

SAVE
YOUR
BREATH



www.gvs.com

GVS Worldwide

FILTER TECHNOLOGY

Trademarks:

HESPA® and Elipse® are trade marks of GVS.

The pleat encapsulation filter technology used in this face mask is patented.

Copyright© 2021 GVS® S.p.A. All rights reserved.

Printed in Italy - Version 250221

www.gvs.com

EUROPE

Italy - Head Office

GVS S.p.A.
Via Roma 50
40069 Zola Predosa (BO) - Italy
tel. +39 051 6176311
gvs@gvs.com

UK

GVS Filter Technology UK
Vickers Industrial Estate
Mellishaw Lane, Morecambe
Lancashire LA3 3EN
tel. +44 (0) 1524 847600
gvsuk@gvs.com

Russia

GVS Russia LLC.
Profsoyuznaya Street, 25-A, office 102
117418, Moscow
Russian Federation (Russia)
tel. +7 495 0045077
gvsrussia@gvs.com

Romania

GVS Microfiltrazione srl
Sat Ciorani de Sus 1E
107156 Ciorani
Prahova România
Tel. +40 244 463044
gvsromania@gvs.com

Turkey

GVS Türkiye
Cevizli mah. Zuhal cad. Ritim Istanbul no:44 A-1
Blok D.371 Maltepe / Istanbul
tel. +90 216 504 47 67
gvssturkey@gvs.com



AMERICA

U.S.A.

GVS North America
63 Community Drive
Sanford, ME 04072 - USA
tel. +1 866 7361250
gvsnasafety@gvs.com

GVS Filtration Inc.
2150 Industrial Dr
Findlay, Ohio, 45840-5402 - USA
tel. +1 419-423-9040

GVS Filtration Inc.
2200 W 20th Ave
Bloomer, Wisconsin, 54724-1918 - USA
tel. +1 715-568-5944

Mexico

Universal No. 550, Vynmsa Aeropuerto
Apodaca Industrial Park,
Ciudad Apodaca, Nuevo León, C.P. 66626
México
tel. +52 81 2282 9003
e-mail: gvs_mex@gvs.com

Brazil

GVS do Brasil Ltda.
Rodovia Conego Cyriaco
Scaranello Pires 251
Jd. Progresso, CEP 13190-000
Monte Mor (SP) - Brasil
tel. +55 19 38797200
gvs@gvs.com.br

Argentina

Parral 246-9° A
1405 Buenos Aires - Argentina
tel. +54 11 49889041
gvsarg@gvs.com

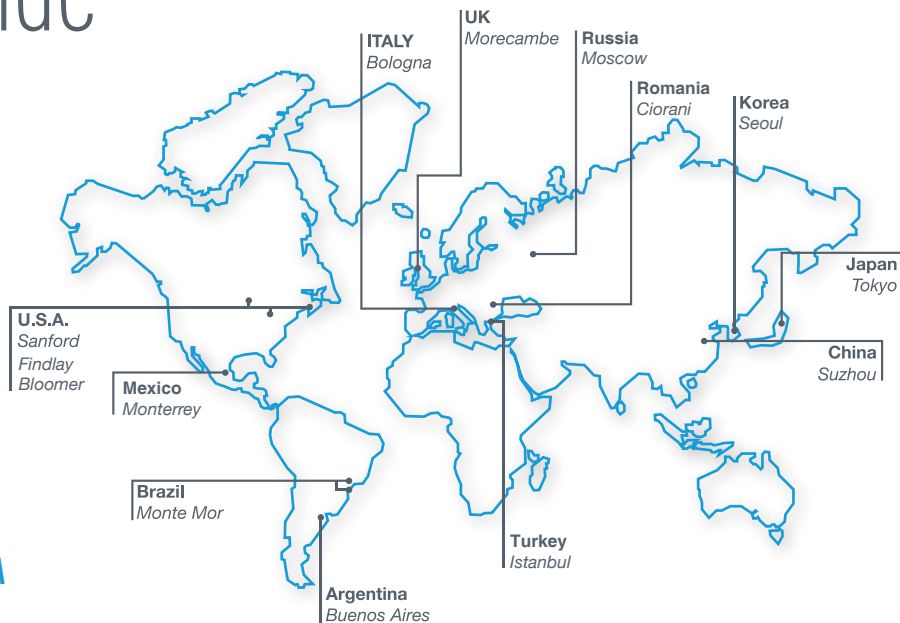

ASIA

China

GVS Technology (Suzhou) Co., Ltd.
Fengqiao Civil-Run Sci-Tech Park,
602 Changjiang Road, S.N.D.
Suzhou, China 215129
tel. +86 512 6661 9880
gvschina@gvs.com

Japan

GVS Japan K.K.
KKD Building 4F, 7-10-12
Nishishinjuku
Shinjuku-ku, Tokyo 160-0023
tel. +81 3 5937 1447
gvsjapan@gvs.com

Korea

GVS Korea Ltd
#315 Bricks Tower
368 Gyungchun-ro (Gaug-dong),
Namyangju-si, Gyunggi-do,
Tel. +82 31 563 9873
gvs-korea@gvs.com

